

EMILE RASSAM

► JOE

Product | Men's Tie
Produit | Cravate Homme

Category | Corporate Wear - Service Wear
Catégorie | Vêtements d'entreprise - Vêtements de Service

Color | Purple
Couleur | Mauve

Item Code | MNT.PLAIN[8255]
Ref. Article |

Fabric | Brocade 100% Polyester
Tissu | Brocart 100% Polyester

Sizes/Tailles:

Unique Size
Taille Unique



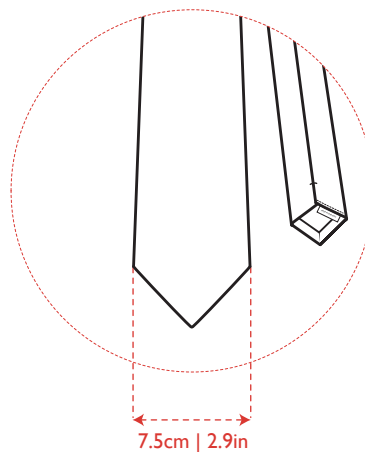
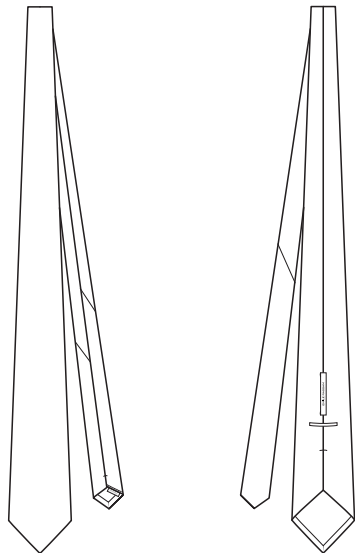

Info

The universal appealing tie that complement and complete every look, without fail.

Fit and Product Details

- Width 7.50cm | 2.9in
- Length 145cm | 57in

Fabric and Care

Woven Brocade
100% Polyester



Do not wash.

Articles marked in this way must not be washed. They may be sensitive to any kind of wet treatment or be unsuitable for washing in a domestic washing machine because of their size.



Do not bleach.

Use only bleach free detergents.



Do not tumble dry.

Use only bleach free detergents.



Iron at moderate temperature.

Iron at maximum sole plate temperature of 160 °C.
A steam iron is recommended. Avoid heavy pressure.



Professional dry-cleaning.

Professional dry-cleaning in: perchloroethylene, hydrocarbons.

Information

La cravate universelle qui élève et complète toute tenue toute fonction.

Ajustement et Détails du Produit

- Largeur 7,5cm | 2.9in
- Longueur 145cm | 57in

Tissu et Soins

Brocart tissé
100% Polyester

Ne pas laver.

Les articles qui comprennent ce symbole ne doivent pas être lavés. Ils peuvent être sensibles au traitement humide ou inappropriés pour un lavage domestique à cause de leur taille.

Ne pas blanchir.

Utiliser des détergents sans chlore.

Séchage en tambour interdit.

Ne pas utiliser de sèche-linge.

Repassage à température modérée.

Repasser à max 160° C (température maximale de la semelle).
Un fer à vapeur est recommandé. Évitez les fortes pressions.

Nettoyage professionnel.

Nettoyage professionnel à sec au perchloroethylene, aux hydrocarbures.



Tips

On how to take measurements of your Male Colleagues.
Visit this link:
<https://youtu.be/tjSR6wMyNQ8?si=G6KWMuBnJOGxrluf>



Consignes

Pour une prise de mesure de vos collaborateurs.
Consulter ce lien:
https://youtu.be/3IwhctcfOfB4?si=ychy_OVb_b_ZsKIQ